

CERAMIC, COAXIAL POWER TETRODE with integral radiator intended for use as U.H.F. amplifier or oscillator at frequencies up to 1000 Mc/s. The coaxial arrangement of the terminals enables the tube to be used as plug in tube in coaxial circuits

TETRODE DE PUISSANCE AVEC ENVELOPPE CERAMIQUE, radiateur incorporé et arrangement coaxial des connexions des électrodes pour utilisation comme amplificatrice ou oscillatrice U.H.F. jusqu'à 1000 MHz. Par suite de l'arrangement coaxial des connexions des électrodes le tube peut être inséré facilement dans les circuits coaxiaux

PRESSLUFTGEKÜHLTE LEISTUNGSTETRODE MIT KERAMISCHER UMHÜLLUNG und koaxialer Anordnung der Elektrodenanschlüsse zur Verwendung als UHF-Verstärker oder Oszillator bis zu 1000 MHz. Die koaxiale Anordnung der Elektrodenanschlüsse ermöglicht ein bequemes Einstecken der Röhre in die zugehörigen koaxialen Stromkreise

Filament : thoriated tungsten

Filament : tungstène thorié

Glühfaden: thoriertes Wolfram

Heating : direct

$V_f = 4 \text{ V}$

Chauffage: direct

$I_f = 60 \text{ A}$

Heizung : direkt

After the circuit has been adjusted for proper tube operation, the filament voltage should be reduced to a value slightly above that at which performance is affected. H.F. voltages on the filament should be avoided

Après le réglage du circuit pour le meilleur fonctionnement du tube, la tension de chauffage doit être diminuée jusqu'à une valeur un peu plus haute que celle à laquelle le fonctionnement est nuí. Il faut prévenir des tensions H.F. au filament

Nachdem die Schaltung auf optimale Wirkung der Röhre eingestellt ist, muss die Heizspannung so weit verringert werden, dass die richtige Wirkung grade nicht beeinträchtigt wird. HF-Spannungen auf dem Glühfaden sollen vermieden werden.

Typical characteristics

$V_a = 3000 \text{ V}$

Caractéristiques types

$V_{g2} = 500 \text{ V}$

Kenndaten

$I_a = 0,48 \text{ A}$

$S = 20 \text{ mA/V}$

$\mu_{g2g1} = 9$

Freq. Mc/s	C telegr.	
	V_{a-g1} (kV)	W_o (W)
600	3,11	2070
900	3,11	1500

CERAMIC, COAXIAL, FORCED AIR COOLED POWER TETRODE with integral radiator for use as U.H.F. amplifier or oscillator at frequencies up to 1000 Mc/s. The coaxial arrangement of the terminals enables the tube to be used as plug in tube in coaxial circuits.

FILAMENT: thoriated tungsten

HEATING:: direct

Filament voltage $V_f = 4 \text{ V}$
 Filament current $I_f = 60 \text{ A}$
 Filament surge current $I_{f\text{surge}} = \text{max.} 150 \text{ A}$

After the circuit has been adjusted for proper tube operation, the filament voltage should be reduced to a value slightly above that at which performance is affected. H.F. voltages on the filament should be avoided.

TYPICAL CHARACTERISTICS

Anode voltage $V_a = 3000 \text{ V}$
 Grid No.2 voltage $V_{g_2} = 500 \text{ V}$
 Anode current $I_a = 0.48 \text{ A}$
 Mutual conductance $S = 20 \text{ mA/V}$
 Amplification factor of grid No.2 with respect to grid No.1 $\mu_{g_2g_1} = 9$

Freq. (Mc/s)	C telegr.	
	V_{a-g_1} (kV)	W_o (W) ¹⁾
800	4.31	2100

Freq. (Mc/s)	Television service		
	Neg.mod.		Pos.synchr.
	V_{a-g_1} (kV)	W_o sync ¹⁾ (W)	W_o black ¹⁾ (W)
800	4.32	2200	1300

CAPACITANCES

Grounded cathode

Grid No.1 to all other electrodes except anode $C_{g_1} = 46 \text{ pF}$
 Anode to all other electrodes except grid No.1 $C_a = 6.0 \text{ pF}$
 Anode to grid No.1 $C_{ag_1} = 0.15 \text{ pF}$

¹⁾ Useful power in the load

Capacitances
Capacités
Kapazitäten

Grounded cathode
Cathode mise à la terre
Katodenbasisschaltung

Grounded g_1 and g_2
 g_1 et g_2 mise à la terre
Gitterbasisschaltung (g_1
und g_2 geerdet)

$$C_{ag1} = 0,15 \text{ pF}$$

$$C_{ag2} = 7 \text{ pF}$$

$$C_a = 6,0 \text{ pF}$$

$$C_{af} = 0,02 \text{ pF}$$

$$C_{g1} = 46 \text{ pF}$$

$$C_{g1f} = 20 \text{ pF}$$

Temperatures and cooling
Températures et refroidissement
Temperaturen und Kühlung

Temperature of envelope
Température de l'enveloppe = max: 200 °C
Temperatur der Umhüllung

Forced air cooling will be required for the radiator and for the ceramic to metal seals. The distribution of the cooling air will vary with the cavity configuration around the tube

Ventilation forcée sera nécessaire pour le radiateur et pour les scellements entre les parties céramiques et métalliques. La distribution de l'air de refroidissement se changera avec la configuration des cavités autour du tube.

Pressluftkühlung ist erforderlich für den Radiator und für die Anschmelzungen zwischen den keramischen und metallenen Teilen. Die Verteilung des Luftstromes hängt von der Anordnung der Hohlräume um die Röhre ab

Air cooling characteristics for the anode radiator (For air duct see page 4)

Caractéristiques de refroidissement par air du radiateur anodique (Pour la conduite d'air voir page 4)

Luftkühlungsdaten des Anodenradiators (Für die Luftleitung siehe Seite 4)

W_a (W)	h (m)	t_1 (°C)	q_{min} (m ³ /min)	P_i (mm H ₂ O)
800	0	35	1,4	16
	0	45	1,6	20
	1500	35	1,65	19
	3000	25	1,7	18
1200	0	35	1,9	29
	0	45	2,2	38
	1500	35	2,25	35
	3000	25	2,35	34

CAPACITANCES (continued)Grounded grids No. 1 and 2

Anode to grid No.2	$C_{ag2} = 7 \text{ pF}$
Grid No.1 to filament	$C_{g1f} = 20 \text{ pF}$
Anode to filament	$C_{af} = 0.02 \text{ pF}$

TEMPERATURE LIMITS AND COOLING

Temperature of all seals = max. 200 °C

Anode temperature = max. 180 °C

For the measurement of the anode temperature see note 4) page 3.

Cooling data for the anode radiator

For recommended cooling arrangement see page 4

Anode dissipation W_a (W)	Height h (m)	Max.air inlet temp. t_1 (°C)	Min. air flow q (m ³ /min.)	Pressure P_1 (mm H ₂ O)
1500	0	45	3.2	75

Remarks

Forced air cooling for the radiator and for the ceramic to metal seals will be required before and during the application of any voltage. After switching off voltages the cooling must be maintained for at least two minutes. The distribution of the cooling air will vary with the cavity configuration around the tube.

The grids and anode connections should be preferably made of contact finger stock. The fingers shall make good electrical contact with the cylindrical planes of the electrode connections. In order to avoid local temperature differences along the circumference of the seals especially at the higher frequencies the contacts shall secure a good and uniform heat conduction.

The filament connections shall provide for good electrical contacts and sufficient heat conduction.

Slots of sufficient width should be provided between the finger contacts to allow for passing of the cooling air.

The amount and temperature of the cooling air shall be watched during operation. If the amount of cooling air decreases below the specified value all voltages shall be switched off automatically.

The cooling air shall be filtered to prevent the radiator from being choked.

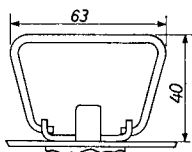
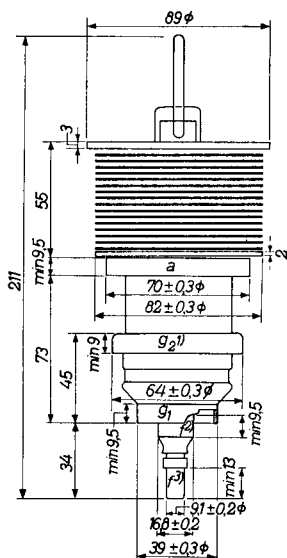

Dimensions in mm
Dimensions en mm
Abmessungen in mm

Mounting position: vertical
Montage : vertical
Einbau : senkrecht

Net weight
Poids net 1900 g
Nettogewicht

- 1) Max. eccentricity with respect to the axis a-g₁ 0,3 mm
Excentricité par rapport à l'axe a-g₁ 0,3 mm au max.
Exzentrizität in bezug auf die Achse a-g₁ max. 0,3 mm
- 2) Max. eccentricity with respect to the axis a-g₁ 0,4 mm
Excentricité par rapport à l'axe a-g₁ 0,4 mm au max.
Exzentrizität in bezug auf die Achse a-g₁ max. 0,4 mm
- 3) Max. eccentricity with respect to the axis a-g₁ 0,8 mm
Excentricité par rapport à l'axe a-g₁ 0,8 mm au max.
Exzentrizität in bezug auf die Achse a-g₁ max. 0,8 mm

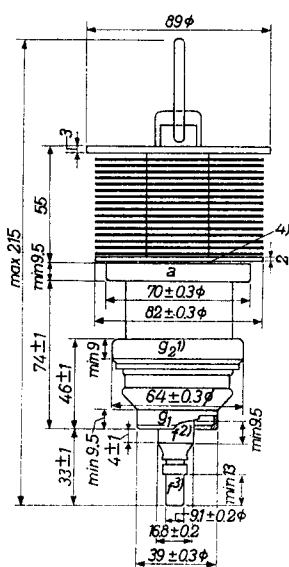

Dimensions in mm

Mounting position: vertical

Net weight 1900 g

- 1) Eccentricity with respect to the axis through anode and grid No.1 max. 0.3 mm
- 2) Cathode return terminal. Eccentricity with respect to the axis through anode and grid No.1 max. 0.4 mm
- 3) Eccentricity with respect to the axis through anode and grid No.1 max. 0.8 mm
- 4) Point for anode temperature measurement

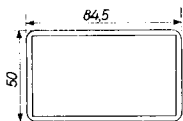

Dimensions in mm
Dimensions en mm
Abmessungen in mm

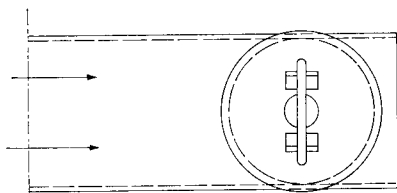
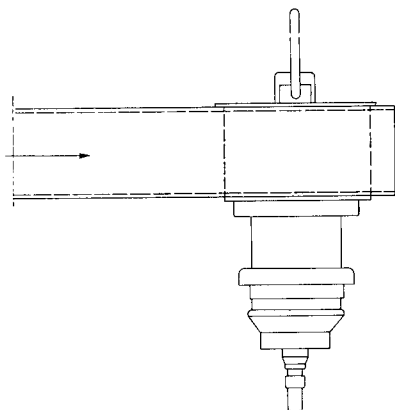

¹) A tunable coaxial circuit is built between g_1 and g_2 which introduces a variable capacitive reactance between g_1 and g_2 . The results are a better efficiency and negligible regeneration from anode to cathode
Un circuit coaxial syntonisable est monté entre g_1 et g_2 ce qui introduit une réactance capacitive variable entre g_1 et g_2 . Les résultats sont un meilleur rendement et une régénération négligeable de l'anode vers la cathode

Ein abstimmbarer Koaxialkreis ist zwischen g_1 und g_2 montiert, was eine veränderliche, kapazitive Reaktanz zwischen g_1 und g_2 ergibt. Hierdurch werden ein besserer Wirkungsgrad und eine vernachlässigbare Rückwirkung von Anode nach Katode erhalten

²) Driver output power
Puissance de sortie de l'étage pré-amplificateur
Ausgangsleistung der Treiberstufe

Recommended cooling arrangement

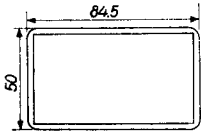

Dimensions in mm

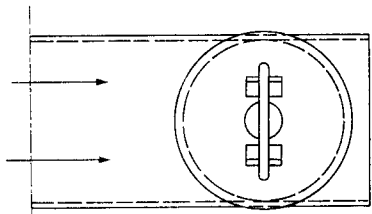
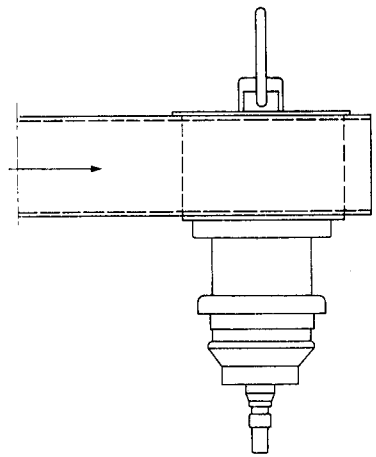

U.H.F. power amplifier, class C telegraphy, cathode driven
 Amplificateur de puissance U.H.F., class C télégraphie,
 à commande par cathode
 UHF-Leistungsverstärker, Klasse C Telegraphie, mit Kat-
 todensteuerung

Voltages with respect to ϵ_1
 Les tensions par rapport à ϵ_1
 Spannungen in bezug auf ϵ_1

Limiting values (Absolute limits)
 Caractéristiques limites (Limites absolues)
 Grenzdaten (Absolute Grenzwerte)

f	= max.	200	Mc/s		
V_a	= max.	3500	V	W_{g2}	= max. 50 W
W_a	= max.	1200	W	I_{g2}	= max. 75 mA
I_a	= max.	0,95	A	I_{g1}	= max. 100 mA
V_{g2}	= max.	700	V	V_k	= max. 300 V

Operating conditions
 Caractéristiques d'utilisation
 Betriebsdaten

f	=	600	900	Mc/s
V_a	=	3110	3110	V
V_{g2}	=	610	610	V
V_k	=	110	110	V
I_a	=	0,9	0,8	A
I_{g2}	=	0,02	0,02	A
I_{g1}	=	0,06	0,06	A
W_1	=	170	200	W ²⁾
W_a	=	770	1040	W
W_o	=	2070	1500	W ³⁾
W_l	=	1760	1280	W ⁴⁾
W_o/W_1	=	12	7,5	

1)2) See page 4; voir page 4; siehe Seite 4

3) Power transferred from the driver stage included
 Y compris la puissance transmise de l'étage pré-amplificateur
 Einschliesslich der von der Treiberstufe übertragenen Leistung

4) Useful power in the load, measured in a circuit having an efficiency of 85%
 Puissance utile dans la charge, mesurée dans un circuit avec un rendement de 85%
 Nutzleistung in der Belastung, gemessen in einer Schaltung mit einem Wirkungsgrad von 85%

U.H.F. power amplifier, class C telegraphy; cathode driven

A tunable coaxial circuit is built between grids No.1 and 2 which introduces a variable capacitive reactance between these grids. The results of this arrangement are better efficiency and negligible regeneration from anode to cathode

The reference point for the electrode voltages is the terminal of grid No.1

LIMITING VALUES (Absolute limits)

Frequency	f	up to 900 Mc/s
Anode voltage	V_{a-g_1}	= max. 4500 V
Anode dissipation	W_a	= max. 1500 W
Input power	W_{1a}	= max. 3800 W
Anode current	I_a	= max. 0.9 A
Grid No.2 voltage	$V_{g_2-g_1}$	= max. 700 V
Grid No.2 dissipation	W_{g_2}	= max. 50 W
Grid No.2 current	I_{g_2}	= max. 75 mA
Grid No.1 current	I_{g_1}	= max. 100 mA
Cathode voltage	V_{k-g_1}	= max. 300 V

OPERATING CONDITIONS

Frequency	f	= 800 Mc/s
Anode voltage	V_{a-g_1}	= 4310 V
Grid No.2 voltage	$V_{g_2-g_1}$	= 600 V
Cathode voltage	V_{k-g_1}	= 110 V
Anode current	I_a	= 0.85 A
Grid No.2 current	I_{g_2}	= 28 mA
Grid No.1 current	I_{g_1}	= 50 mA
Driver output power	W_{dr}	= 180 W
Useful power in load	W_{ℓ}	= 2100 W ¹⁾
Power gain	W_{ℓ}/W_{dr}	= 12

¹⁾ Typical value, measured in a circuit having an efficiency of approximately 85%

U.H.F. class C amplifier for television service, 1)
 cathode modulated, cathode driven; negative
 modulation, positive synchronisation
 Amplificateur U.H.F. classe C pour service de télévision,
 modulation cathodique et commande cathodique; modulation
 négative, synchronisation positive
 UHF-Klasse C-Verstärker für Fernsehbetrieb mit Katoden-
 modulation und Katodensteuerung; negative modulation,
 positive Synchronisierung

Voltages with respect to ξ_1
 Les tensions par rapport à ξ_1
 Spannungen in bezug auf ξ_1

Limiting values (Absolute limits)
 Caractéristiques limites (Limites absolues)
 Grenzdaten (Absolute Grenzwerte)

f ----- = max. 900 Mc/s

V_a	= max. 3700 V	W_{ξ_2}	= max. 50 W
W_a	= max. 1200 W	I_{ξ_2} sync	= max. 75 mA
I_a sync	= max. 0,95 A	I_{ξ_1} sync	= max. 0,1 A
V_{ξ_2} sync	= max. 700 V	V_k	= max. 500 V

Operating conditions
 Caractéristiques d'utilisation
 Betriebsdaten

f	= 800 Mc/s
B (-3 db)	= 6 Mc/s
V_a	= 3610 V
V_{ξ_2}	= 610 V
V_k sync	= 110 V
V_k black, noir, schwarz	= 210 V
V_k white, blanc, weiss	= 380 V
I_a sync	= 0,9 A
I_a black, noir, schwarz	= 0,6 A
I_{ξ_2} sync	= 15 mA
I_{ξ_2} black, noir, schwarz	= 6 mA
I_{ξ_1} sync	= 50 mA
I_{ξ_1} black, noir, schwarz	= 20 mA
W_1 sync	= 180 W
W_0 sync	= 2000 W
W_0 black, noir, schwarz	= 1120 W

1) See page 4; voir page 4; siehe Seite 4.

→ U.H.F. class C amplifier for television service, grid modulated, cathode driven; negative modulation, positive synchronisation

A tunable coaxial circuit is built between grids No.1 and 2 which introduces a variable capacitive reactance between these grids. The results of this arrangement are better efficiency and negligible regeneration from anode to cathode

The reference point for the electrode voltages is the terminal of grid No.1

LIMITING VALUES (Absolute limits)

Frequency	f	up to	900 Mc/s
Anode voltage	V_{a-g_1}	= max.	4500 V
Anode dissipation	W_a	= max.	1500 W
Input power	W_{i_a}	= max.	4000 W
Anode current	I_a sync	= max.	0.95 A
Grid No.2 voltage	$V_{g_2-g_1}$ sync	= max.	700 V
Grid No.2 dissipation	W_{g_2}	= max.	50 W
Grid No.2 current	I_{g_2} sync	= max.	75 mA
Grid No.1 current	I_{g_1} sync	= max.	100 mA
Cathode voltage	V_{k-g_1}	= max.	500 V

OPERATING CONDITIONS

Frequency	f	=	800 Mc/s
Bandwidth at -3 dB	$B(-3 \text{ dB})$	=	6 Mc/s
Anode voltage	V_{a-g_1}	=	4320 V
Grid No.2 voltage	$V_{g_2-g_1}$	=	600 V
Cathode voltage	sync	$V_{k-g_1 \text{ sync}}$	= 120 V
	black	$V_{k-g_1 \text{ black}}$	= 175 V
	white	$V_{k-g_1 \text{ white}}$	= 345 V
Anode current	(sync)	I_a sync	= 0.9 A
	(black)	I_a black	= 0.68 A
Grid No.2 current	(sync)	I_{g_2} sync	= 15 mA
	(black)	I_{g_2} black	= 5 mA
Grid No.1 current	(sync)	I_{g_1} sync	= 50 mA
	(black)	I_{g_1} black	= 35 mA
Driver output power	W_{dr} sync	=	220 W
Useful power in load	(sync)	W_l sync	= 2200 W ¹⁾
	(black)	W_l black	= 1300 W ¹⁾
Power gain	W_l/W_{dr}	=	10

1) Typical value, measured in a circuit having an efficiency of approximately 85 %

7Z00694

QBL3,5/2000 25-9-1961

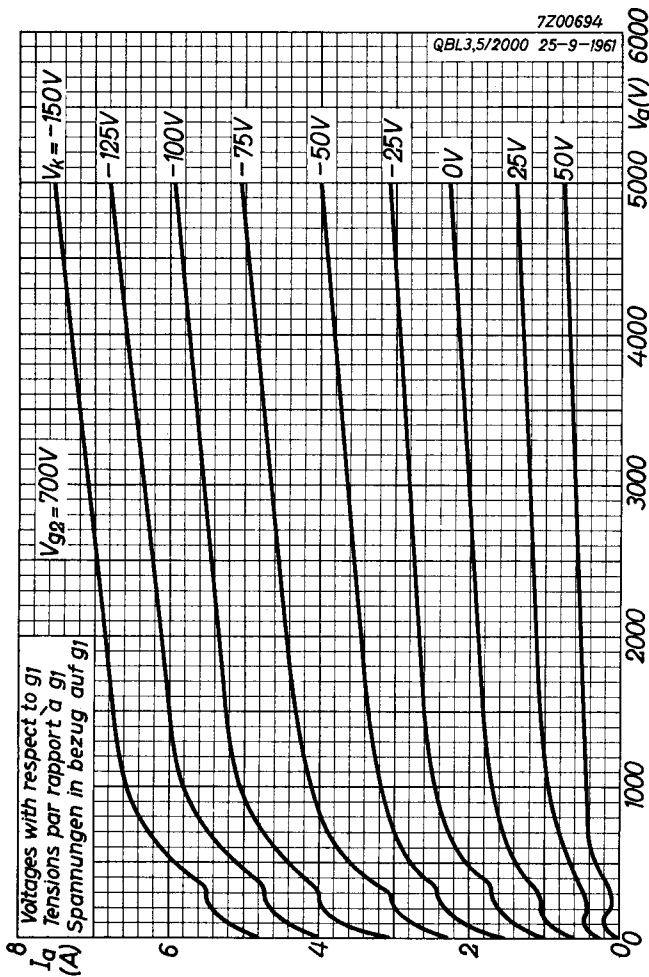

10.10.1961

A

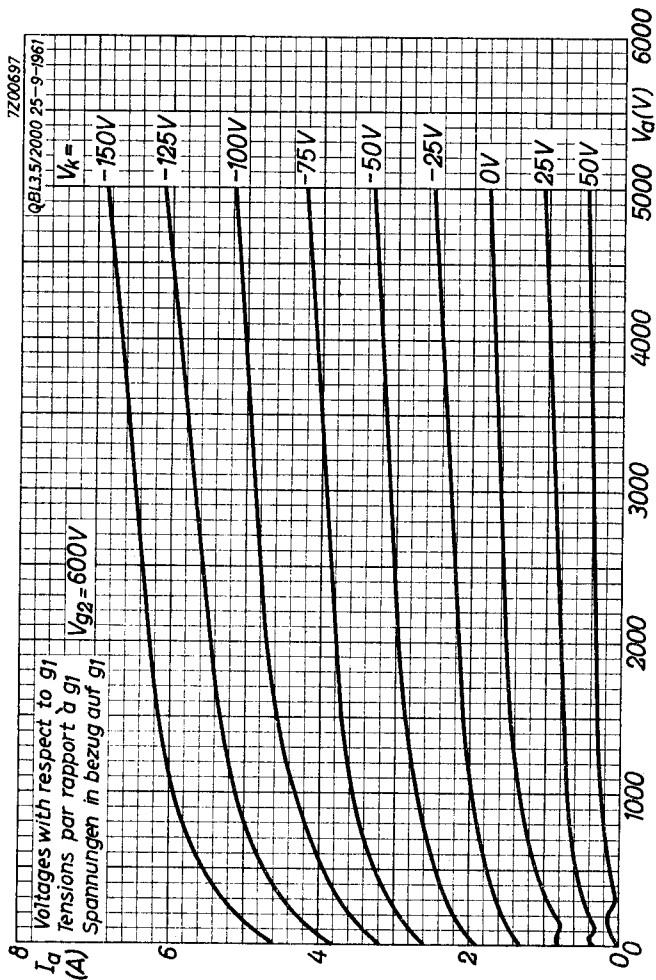

7200699

QBL3.5/2000 25-9-1961

1500
 I_{g2}
(mA)

$V_{g2} = 700V$

Voltagés with respect to $g1$
Tensions par rapport à $g1$
Spannungen in bezug auf $g1$

$V_k =$
-150V
-125V
-100V
-75V
-50V
-25V
0V

1000

500

25V

50V

B

5000

4000

3000

2000

1000

00

$V_d(V)$

7200698

QBL3.5/2000 25-9-1961

$V_{g2} = 600V$

Voltages with respect to g_1
Tensions par rapport à g_1
Spannungen in bezug auf g_1

1500
 I_{g2}
(mA)

1000

500

0

$V_k =$
- 150V
- 125V
- 100V
- 75V
- 50V
- 25V
- 0V

25V

50V

5000
4000
3000
2000
1000
 $V_a(V)$

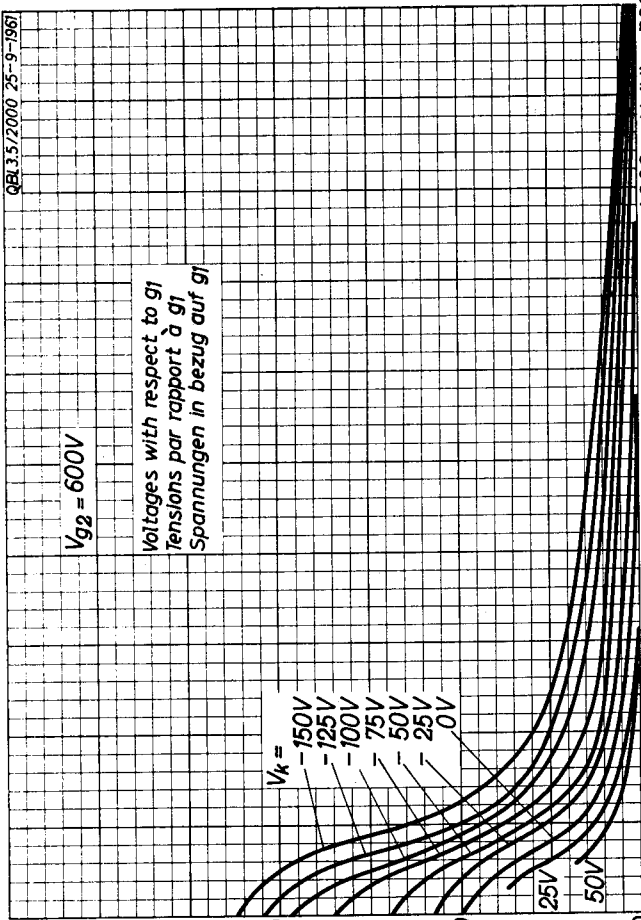

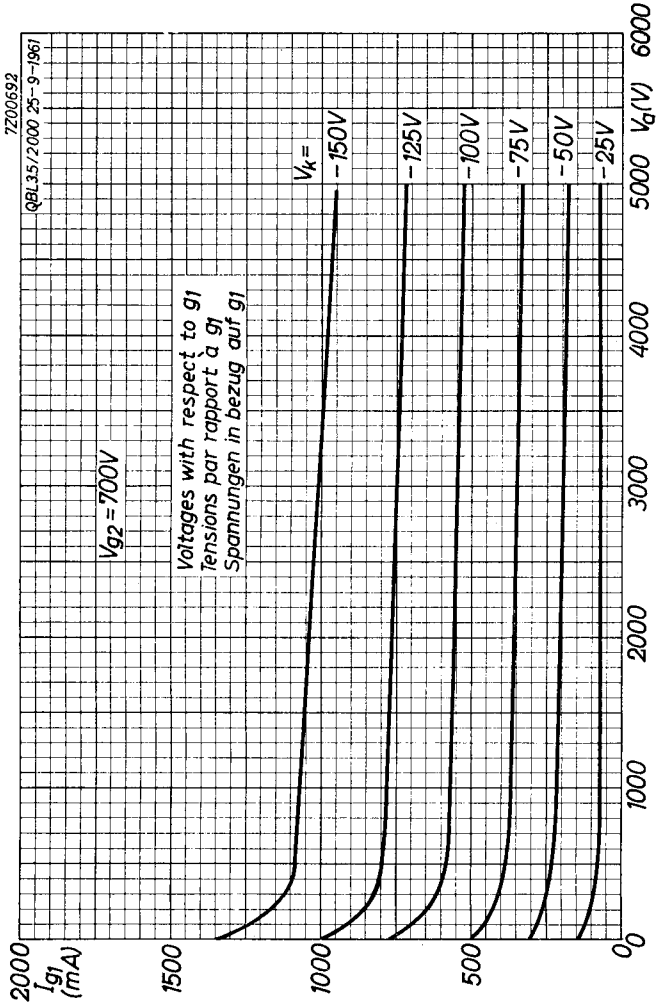

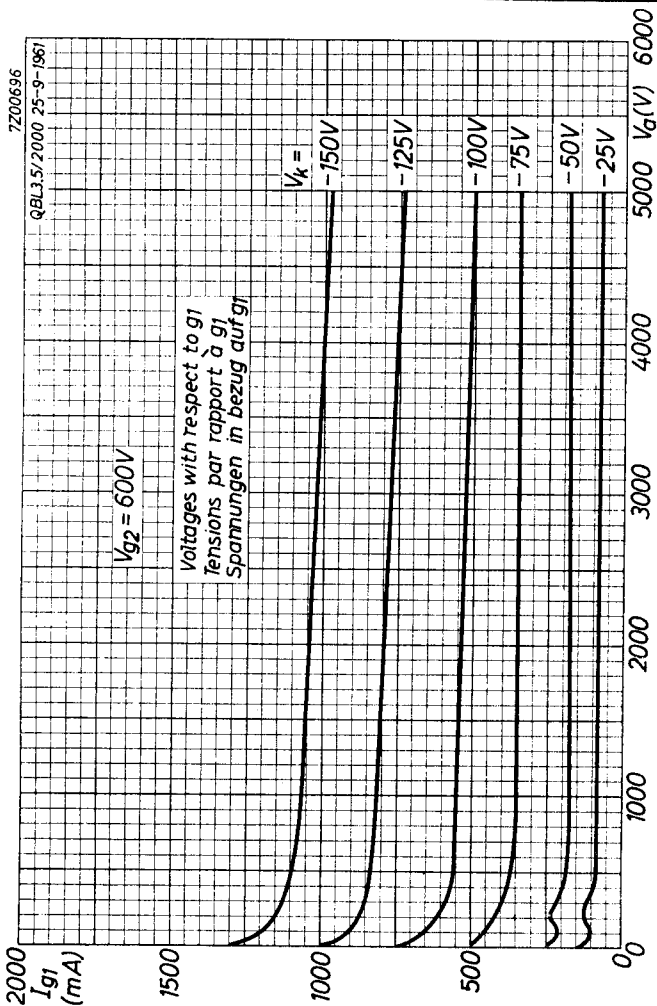

11.11.1962

c

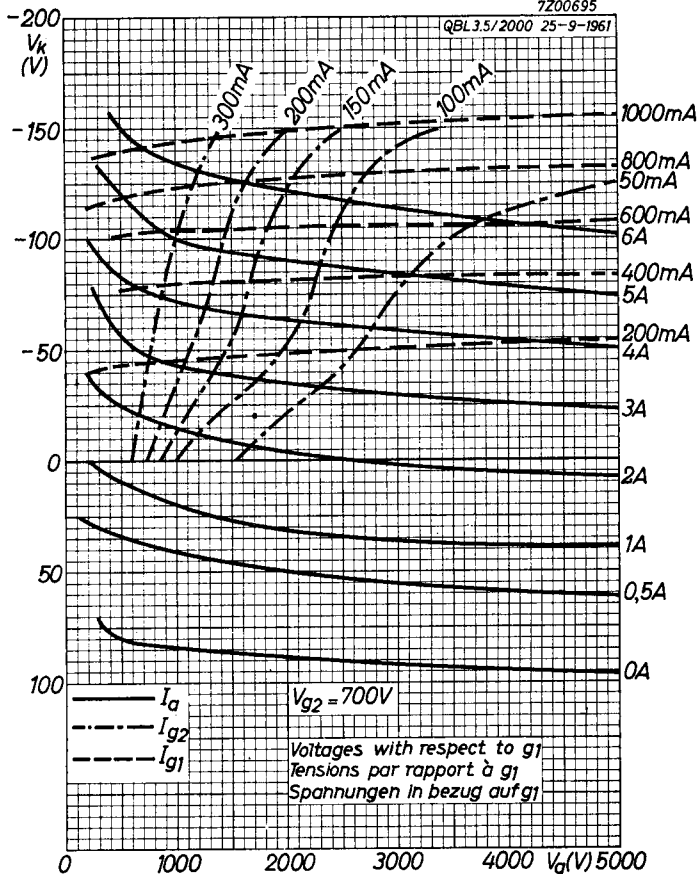

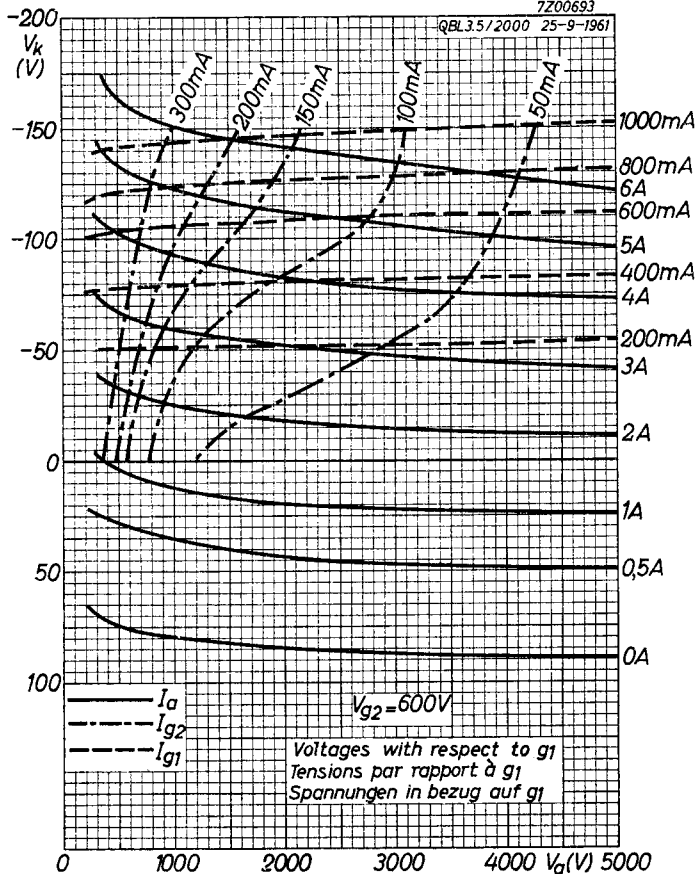

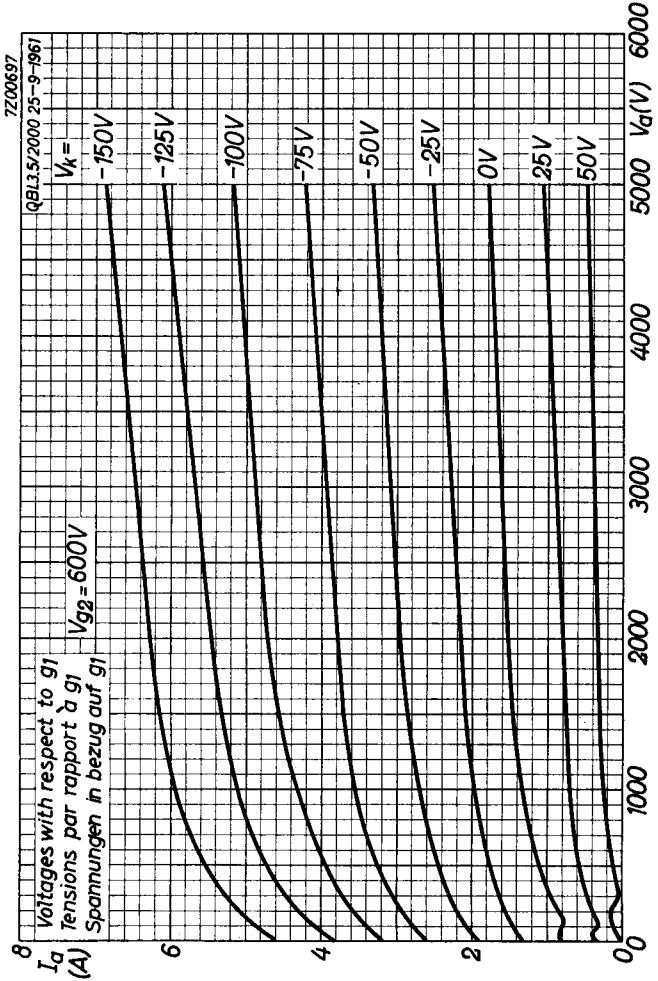

7Z00698

QBL3.5/2000 25-9-1967

$V_{g2} = 600V$

Voltages with respect to g_1
Tensions par rapport à g_1
Spannungen in bezug auf g_1

1500
 I_{g2}
(mA)

$V_k =$
- 150V
- 125V
- 100V
- 75V
- 50V
- 25V
- 0V

25V
50V

η

5000
4000
3000
2000
1000
0

$V_a(V)$

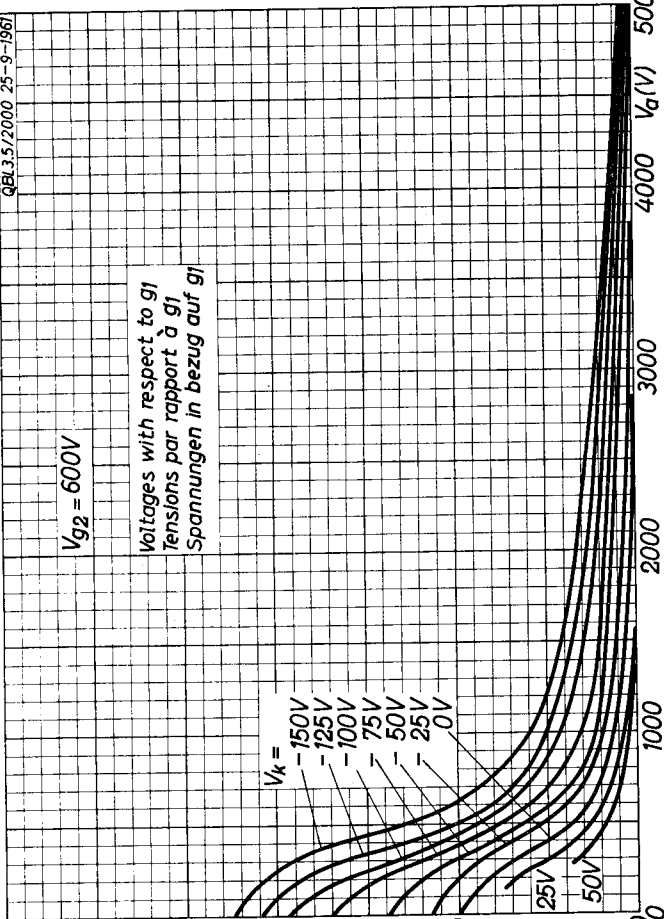

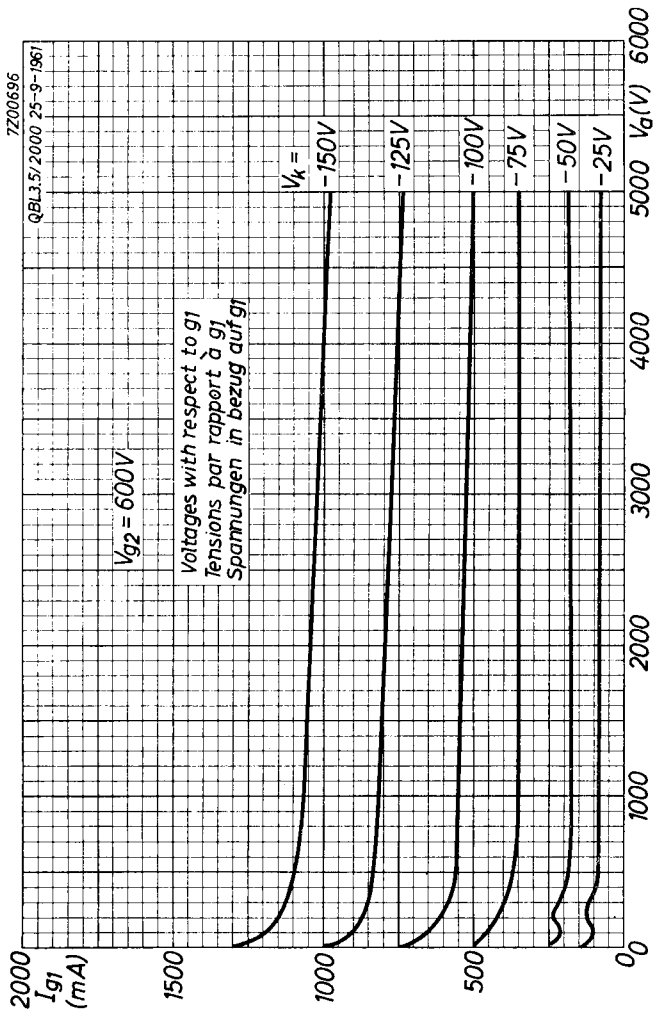

10.10.1961

G

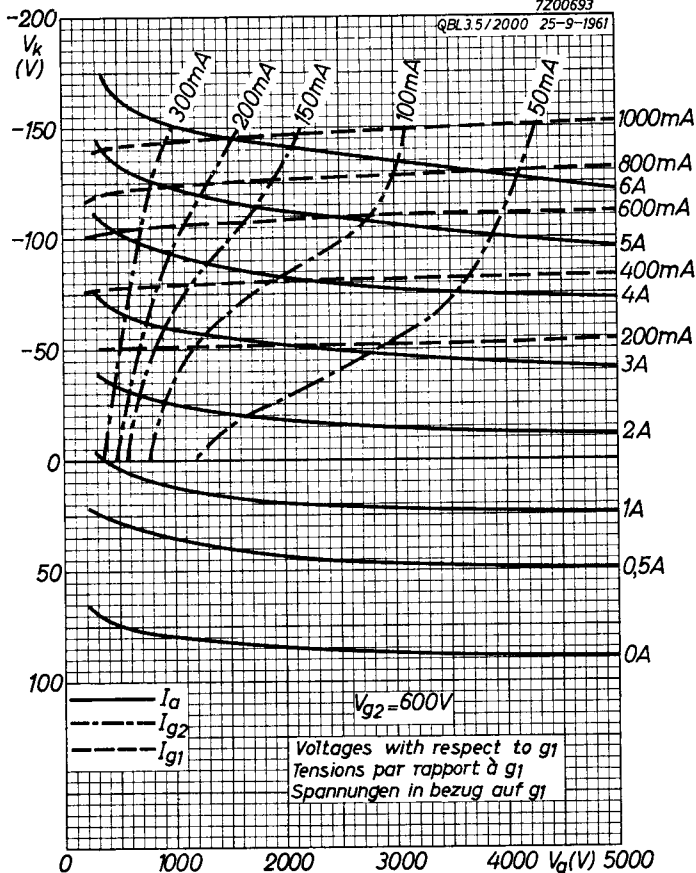

PHILIPS



*Electronic
Tube*

HANDBOOK

QBL3.5/2000

page	sheet	date
1	1	1961.10.10
2	1	1962.11.11
3	2	1961.10.10
4	2	1962.11.11
5	3	1961.10.10
6	3	1962.11.11
7	4	1961.10.10
8	4	1962.11.11
9	5	1961.10.10
10	5	1962.11.11
11	6	1961.10.10
12	6	1962.11.11
13	A	1961.10.10
14	A	1962.11.11
15	B	1961.10.10
16	B	1962.11.11
17	C	1961.10.10
18	C	1962.11.11
19	D	1961.10.10

20	D	1962.11.11
21	E	1961.10.10
22	F	1961.10.10
23	G	1961.10.10
24	H	1961.10.10
25, 26	FP	1999.10.19